

Varenummer: 203280M12125A1S
 Beskrivelse: E+G Justerfod
 GN 32-80-M12-125-A1-S
 Note: S Uden møtrik, udvendig sekskant i bunden

Mål

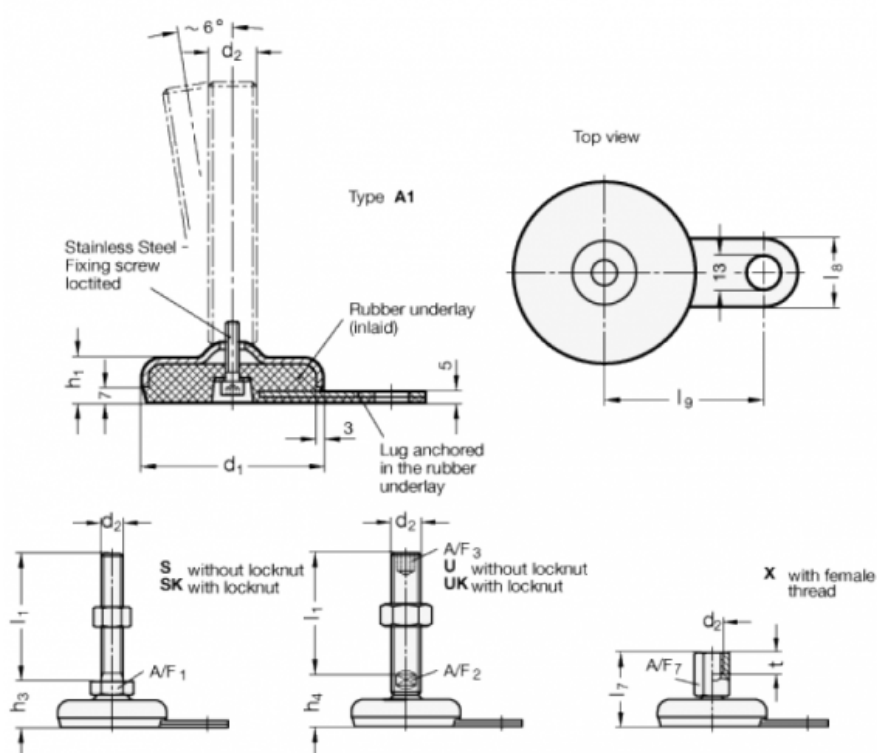

A/F1	= 17
d1	= 80
d2	= M12
h1	= 20
h3	= 28
l1	= 125
l8	= 30
l9	= 70